

Features

- Dual P-Channel MOSFET
- Low On-Resistance
 - 150 mΩ @ $V_{GS} = -4.5V$
 - 200 mΩ @ $V_{GS} = -2.5V$
 - 240 mΩ @ $V_{GS} = -1.8V$
- Very Low Gate Threshold Voltage $V_{GS(th)} \leq 1V$
- Low Input Capacitance
- Fast Switching Speed
- Low Input/Output Leakage
- **Lead Free By Design/RoHS Compliant (Note 2)**
- **"Green" Device (Note 3)**
- **Qualified to AEC-Q101 standards for High Reliability**

Mechanical Data

- Case: SOT-26
- Case Material: Molded Plastic, "Green" Molding Compound. UL Flammability Classification Rating 94V-0
- Moisture Sensitivity: Level 1 per J-STD-020C
- Terminals Connections: See Diagram
- Terminals: Finish — Matte Tin annealed over Copper leadframe. Solderable per MIL-STD-202, Method 208
- Marking Information: See Page 4
- Ordering Information: See Page 4
- Weight: 0.015 grams (approximate)

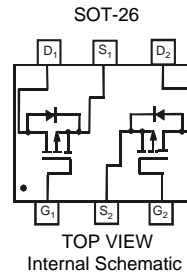
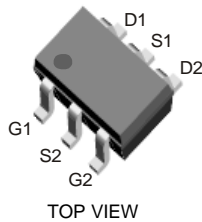

Maximum Ratings @ $T_A = 25^\circ C$ unless otherwise specified

Characteristic	Symbol	Value	Units
Drain-Source Voltage	V_{DSS}	-20	V
Gate-Source Voltage	V_{GSS}	± 12	V
Drain Current (Note 1)	I_D	$T_A = 25^\circ C$	-2.0
		$T_A = 70^\circ C$	-1.5
Pulsed Drain Current	I_{DM}	-7	A

Thermal Characteristics

Characteristic	Symbol	Value	Units
Total Power Dissipation (Note 1)	P_D	600	mW
Thermal Resistance, Junction to Ambient	$R_{\theta JA}$	208	$^\circ C/W$
Operating and Storage Temperature Range	T_j, T_{STG}	-65 to +150	$^\circ C$

- Notes:
1. Device mounted on FR-4 PCB.
 2. No purposefully added lead.
 3. Diodes Inc.'s "Green" policy can be found on our website at http://www.diodes.com/products/lead_free/index.php.

Electrical Characteristics @ $T_A = 25^\circ\text{C}$ unless otherwise specified

Characteristic	Symbol	Min	Typ	Max	Unit	Test Condition
OFF CHARACTERISTICS (Note 4)						
Drain-Source Breakdown Voltage	BV_{DSS}	-20	—	—	V	$V_{GS} = 0V, I_D = -250\mu A$
Zero Gate Voltage Drain Current	I_{DSS}	—	—	-1.0 -5.0	μA	$V_{DS} = -20V, V_{GS} = 0V$ $T_J = 25^\circ\text{C}$ $T_J = 125^\circ\text{C}$
Gate-Source Leakage	I_{GSS}	—	—	± 100	nA	$V_{GS} = \pm 12V, V_{DS} = 0V$
ON CHARACTERISTICS (Note 4)						
Gate Threshold Voltage	$V_{GS(th)}$	-0.45	—	-1.0	V	$V_{DS} = V_{GS}, I_D = -250\mu A$
Static Drain-Source On-Resistance	$R_{DS(on)}$	—	92 134 180	150 200 240	m Ω	$V_{GS} = -4.5V, I_D = -2.0A$ $V_{GS} = -2.5V, I_D = -1.5A$ $V_{GS} = -1.8V, I_D = -0.5A$
Forward Transconductance	g_{FS}	—	3.1	—	S	$V_{DS} = -10V, I_D = -810mA$
Diode Forward Voltage (Note 4)	V_{SD}	—	—	-0.9	V	$V_{GS} = 0V, I_S = -0.5A$
DYNAMIC CHARACTERISTICS						
Input Capacitance	C_{iss}	—	320	—	pF	$V_{DS} = -16V, V_{GS} = 0V$ $f = 1.0MHz$
Output Capacitance	C_{oss}	—	80	—	pF	
Reverse Transfer Capacitance	C_{rss}	—	60	—	pF	

Notes: 4. Short duration pulse test used to minimize self-heating effect.

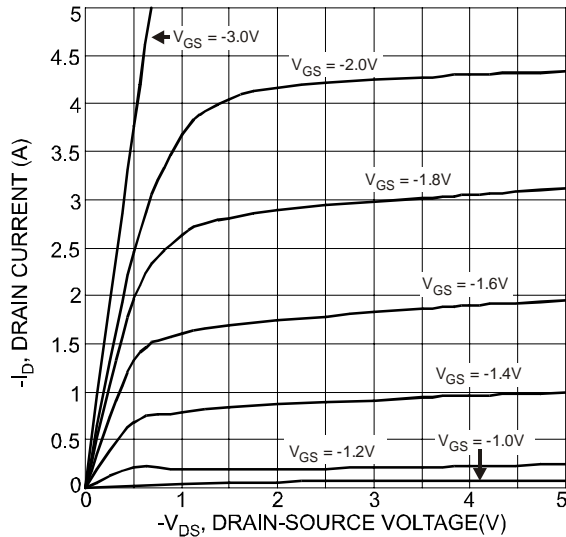

Fig. 1 Typical Output Characteristics

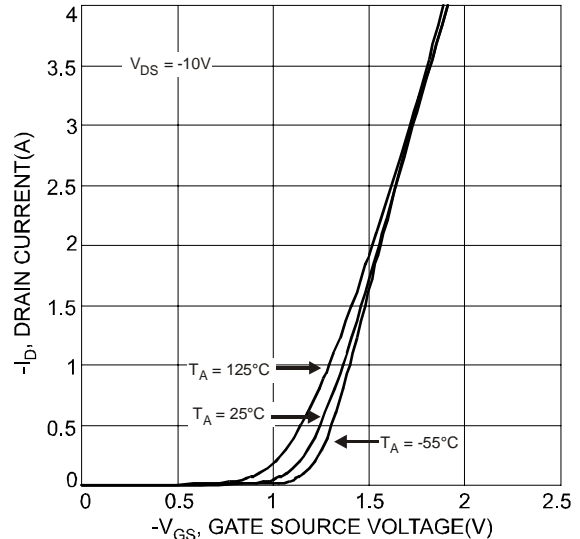

Fig. 2 Typical Transfer Characteristics

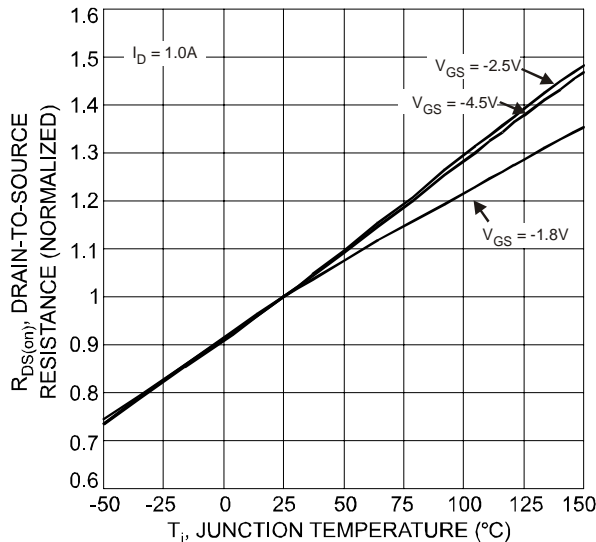

Fig. 3 On-Resistance Variation with Temperature

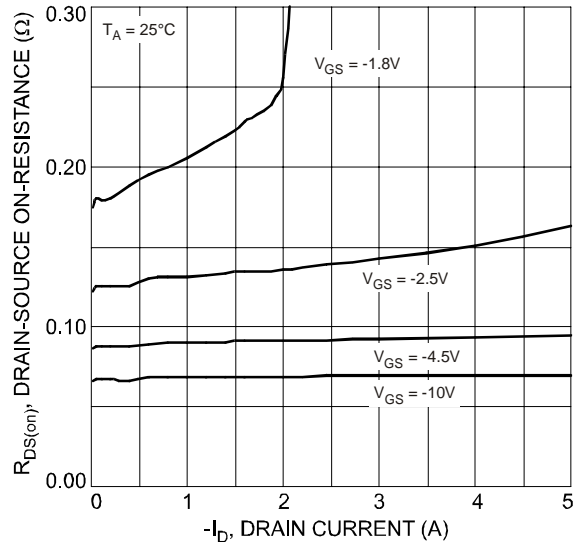

Fig. 4 On-Resistance vs Drain Current and Gate Voltage

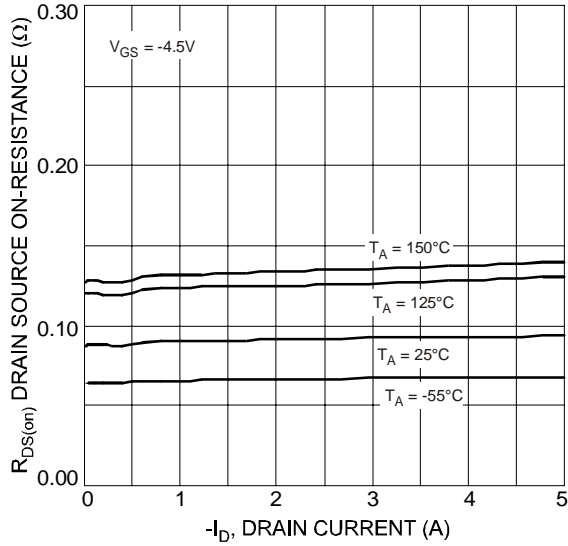

Fig. 5 Drain-Source On-Resistance Vs. Drain Current and Temperature

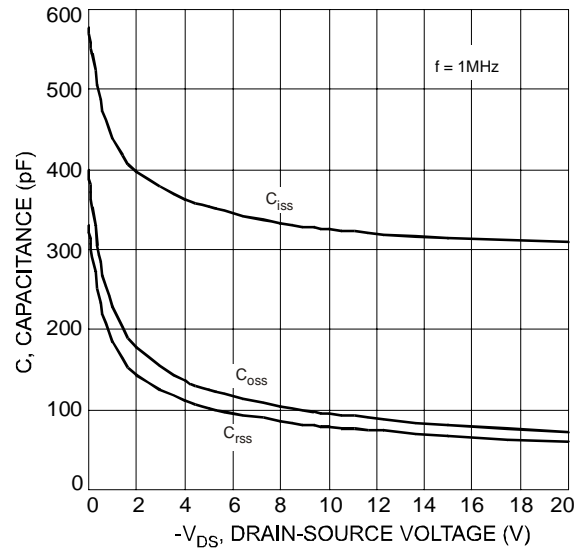

Fig. 6: Typical Capacitance

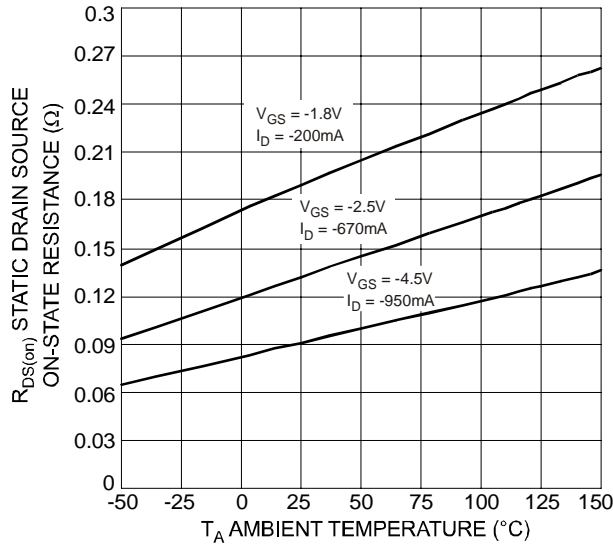

Fig. 7 Static Drain-Source On-State Resistance vs Ambient Temperature

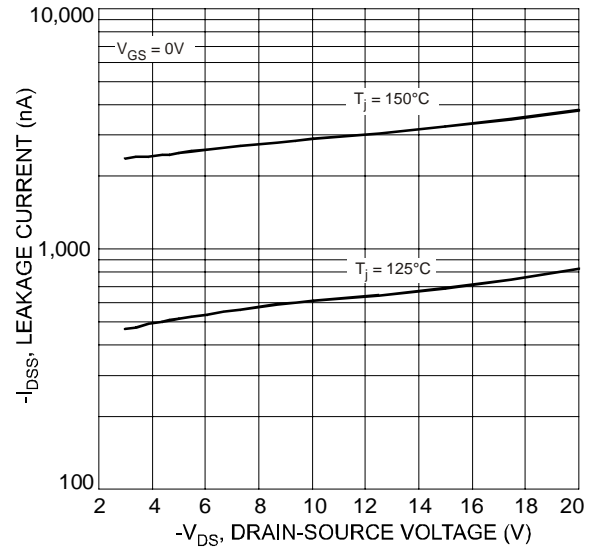

Fig. 8 Drain-Source Leakage Current vs Voltage

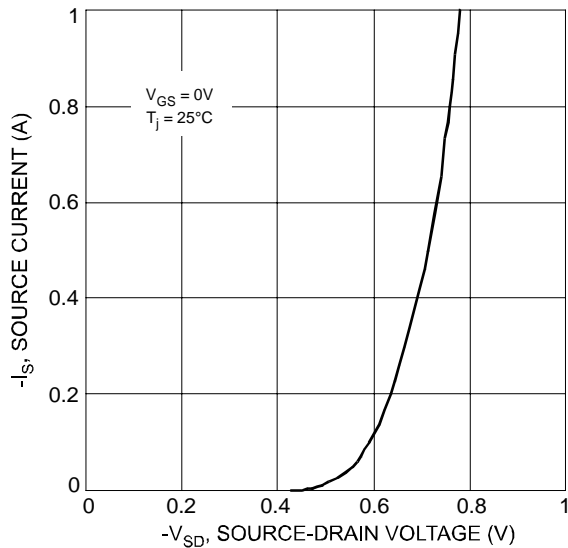

Fig. 9 Diode Forward Voltage vs. Current

Ordering Information (Note 5)

Part Number	Case	Packaging
DMP2240UDM-7	SOT-26	3000/Tape & Reel

Notes: 5. For packaging details, go to our website at <http://www.diodes.com/datasheets/ap02007.pdf>.

Marking Information

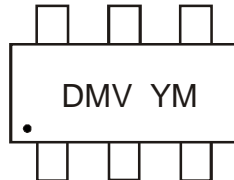

DMV = Marking Code
YM = Date Code Marking
Y = Year ex: U = 2007
M = Month ex: 9 = September

Date Code Key (If Applicable)

Year Code	2007	2008	2009	2010	2011	2012
Year Code	U	V	W	X	Y	Z

Month Code	Jan	Feb	Mar	Apr	May	Jun	Jul	Aug	Sep	Oct	Nov	Dec
Month Code	1	2	3	4	5	6	7	8	9	O	N	D

Package Outline Dimensions

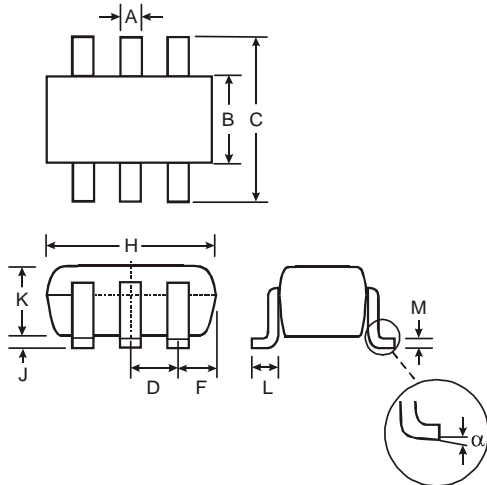

SOT-26			
Dim	Min	Max	Typ
A	0.35	0.50	0.38
B	1.50	1.70	1.60
C	2.70	3.00	2.80
D	-	-	0.95
F	-	-	0.55
H	2.90	3.10	3.00
J	0.013	0.10	0.05
K	1.00	1.30	1.10
L	0.35	0.55	0.40
M	0.10	0.20	0.15
α	0°	8°	-

All Dimensions in mm

Suggested Pad Layout

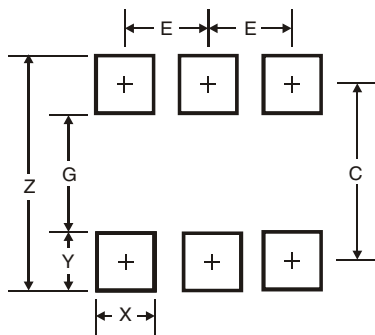

Dimensions	Value (in mm)
Z	3.20
G	1.60
X	0.55
Y	0.80
C	2.40
E	0.95

IMPORTANT NOTICE

Diodes Incorporated and its subsidiaries reserve the right to make modifications, enhancements, improvements, corrections or other changes without further notice to any product herein. Diodes Incorporated does not assume any liability arising out of the application or use of any product described herein; neither does it convey any license under its patent rights, nor the rights of others. The user of products in such applications shall assume all risks of such use and will agree to hold Diodes Incorporated and all the companies whose products are represented on our website, harmless against all damages.

LIFE SUPPORT

Diodes Incorporated products are not authorized for use as critical components in life support devices or systems without the expressed written approval of the President of Diodes Incorporated.